

**FRONTAL VIEW**

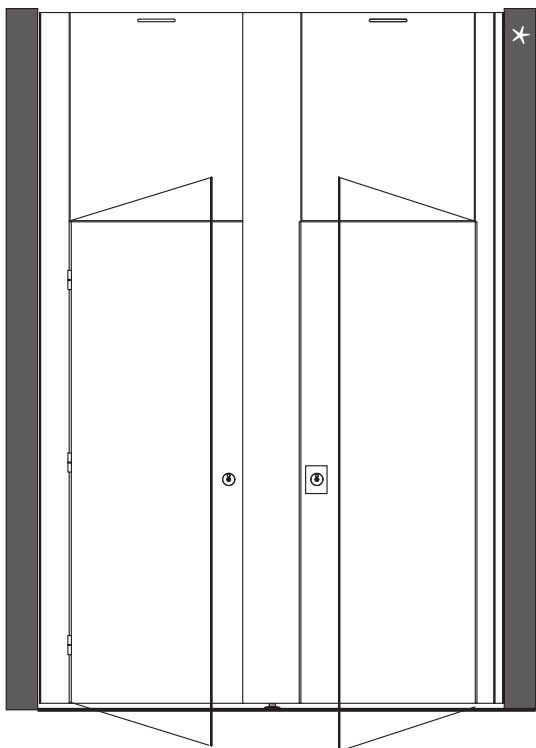

**SIDE VIEW**

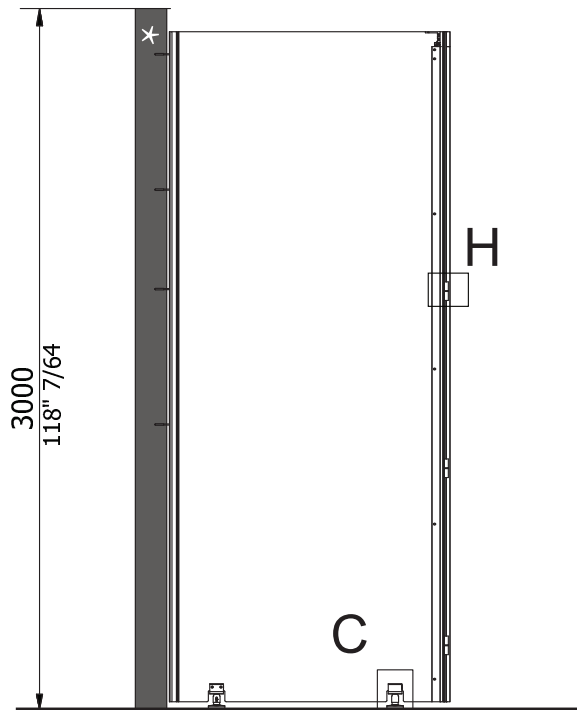

**PLAN**

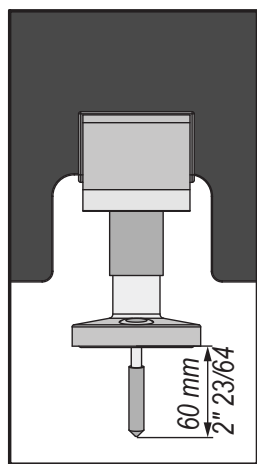

**C.** Leg of divider panel: fastening on the ground.

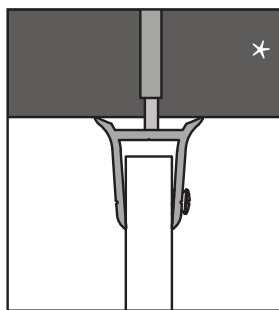

**E.** Divider fastening on the wall.

**G.** Lever lock in stainless steel free/engaged.

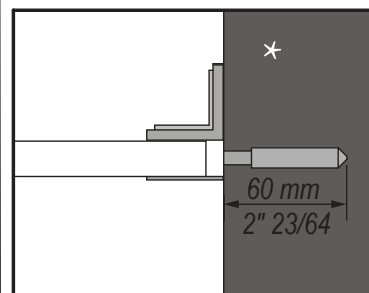
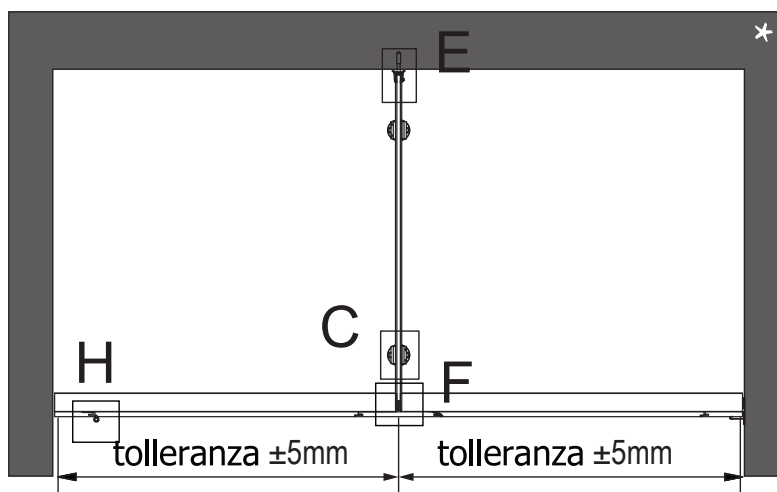
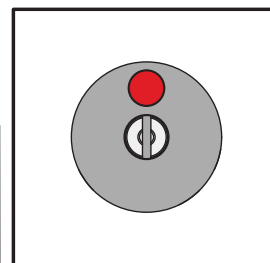

**A.** Wall fixing profile

**F.** Chain fixing

